

21D83M-843

Single Stage Integrated Furnace Control

Lennox Family Brand Replacement

Business and Product Overview

What is it?

The 21D83M-843 is designed to replace the large number of aging Lennox single stage integrated furnace controls in the field

- The kit is a direct drop-in replacement for many models and includes adapter harnesses and plug-in circuit breaker for added application versatility
- Designed for 80V Nitride ignitor systems with single stage PSC blower and inducer motors
- Includes LED diagnostic indicators for quick installation and easy system troubleshooting



Key Features

- Replaces over 40 sku's
- Direct drop-in for most systems with conversion harnesses and circuit breaker to fit additional Lennox applications
- Status & fault LED indicators
- Blower Delay Dipswitches
- Connections for accessory humidifiers and electronic air cleaners
- Complete instructions and easy wiring

White-Rodgers®
Integrated Furnace Control
21D83M-843 | Lennox

Single Stage Applications
PSC Blower Motor
80V HSI Ignition

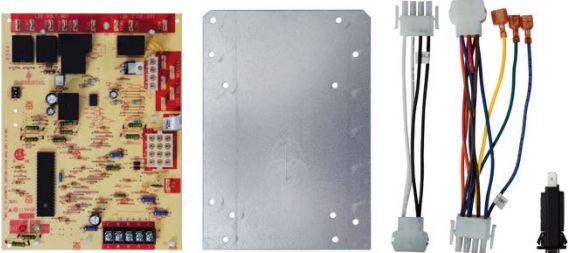

Trusted by **PROs**

1-Year Limited Warranty

OEM Direct

EMERSON
Climate Technologies

Market

The US market for single stage applications offers a huge opportunity for replacements.

21D83M-843 targets high volume older Lennox brand units that featured 80V nitride ignitors

Single Stage Homes Total: **42,065,000**

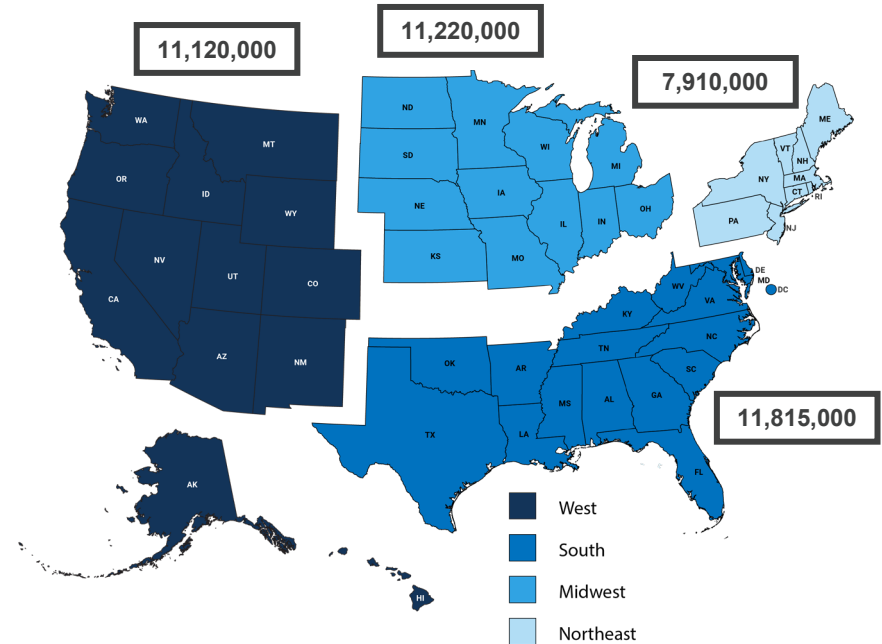

*40 million** single stage gas furnaces were installed in the last twenty years in the US, so the replacement market for these controls should be strong, wherever you are.

21D83M-843 Cross-Reference

Cross-Reference

1. Download WR Mobile for most complete and up-to-date cross reference
2. Check the cross reference list on the side of the box



White-Rodgers™
Integrated Furnace Control
21D83M-843 | Lennox

D
 OEM Direct

Single Stage Applications

PSC Blower Motor

80V HSI Ignition

Trusted by **PROs**

1-Year Limited Warranty

Cross Reference Replacement / Tableau de renvoi des remplacements

Lennox	White-Rodgers
124110	21D83M-843
24L85	50A62-120
24L8501	50A62-121
56L83	50A62-820
56L8301	50A66-843
63K89	
63K8901	
65867	
83M00	
83M001	
97L48	
97L4801	
L39-564	

Features and Benefits

Feature	Function	Benefit
40+ board cross references	Saves inventory space – multiple boards replaced with just one control	Minimizes truck stock
80V Ignitor voltage output	Direct replacement for older 80V controls	Minimizes truck stock/saves time
Extra motor/park terminals	Provides safe landing for extra motor lead wires without having to cut off connectors and seal wire ends	Gives technician quick way to secure extra wires
Electronic air cleaner connection	Powers EAC when fan comes on	Saves time installation time
Humidifier connections	Powers Humidifier on heat call	Saves time installation time
Status & fault LED indicator	Pinpoints system problems during installation and in service	Allows technicians to rapidly troubleshoot and resolve component or connection issues
Multiple OEM mounting options with standoffs and plate mount included	Provides mounting stiles to match original	Saves installation time

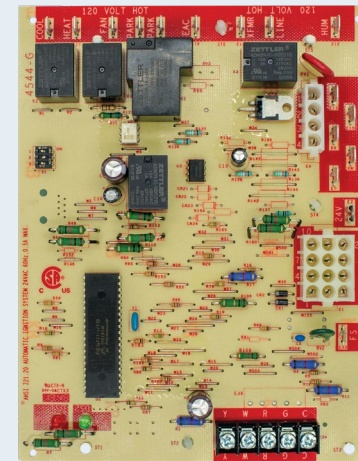

21D83M-843

What Our Customers are Saying About White-Rodgers Integrated Furnace Controls

I would buy this item again for sure!!!

This is a fantastic replacement for the previous SureLight board that was problematic. It came with everything needed and was very easy to install. Very pleased with this board and Supply Warehouse for having it available and ready to ship which was fast.

– Kevin R., November 2021

Works perfectly as a replacement for my older Lennox board.

Came with everything I needed; mount board, standoffs, extra wiring, etc. Some wasn't needed as I just used the existing wiring, but it was still nice to have. The mounting board did have holes that aligned opposite of my config (upside down), but it wasn't a big deal.

– Lee, December 2021

Year later, this board still functions great. Great replacement for original Lennox.

Great replacement for original Lennox G40UH-36A-070X furnace control board that was shutting off after overheating. Installation was easy, instructions were sufficient and easy to follow. This product saved me a lot's of \$\$\$. Thanks White-Rodgers!

– I., 2018



WR Mobile App

Always up-to-date and easy to use:

- Mobile App
- White-Rodgers Website



Your resource for:

- Product information and spec sheets
- Complete Cross Reference
- OEM compatibility
- Installation information and videos
- Wiring diagrams

Download:

- Go to your app store
- Type in **WR Mobile**
- Install the app



OR

- Open your camera
- Hold it over the QR code
- Tap “Open” on the pop-down
- Install the app



WR Mobile App

Easy to use!

Search by OEM, Competitive, or White-Rodgers Model Number



Product Number

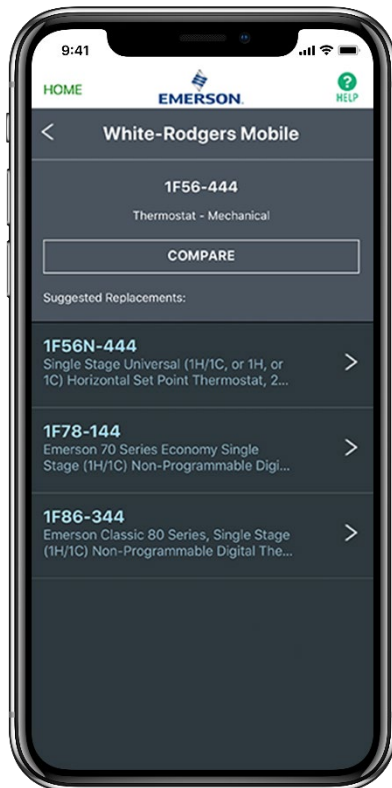

Scrollable Product List

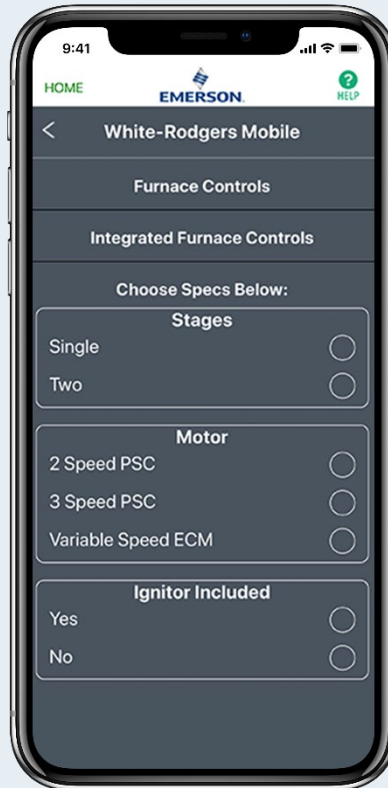

21D83M-843 Single Stage IFC

WR Replacement

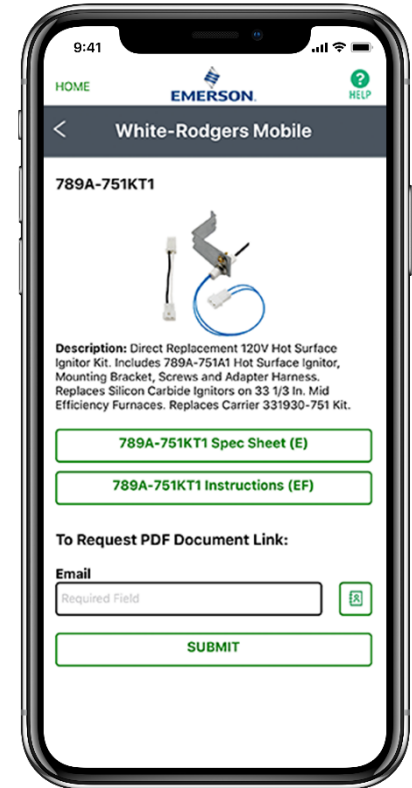

White-Rodgers Cross Reference

Go to: www.whiterodgers.com

- Hover over Tools & Resources
- Click on: White-Rodgers Cross Reference/Product Information
- Enter the Model Number or click on: Search Replacement Heating Controls by Major OEM Brand

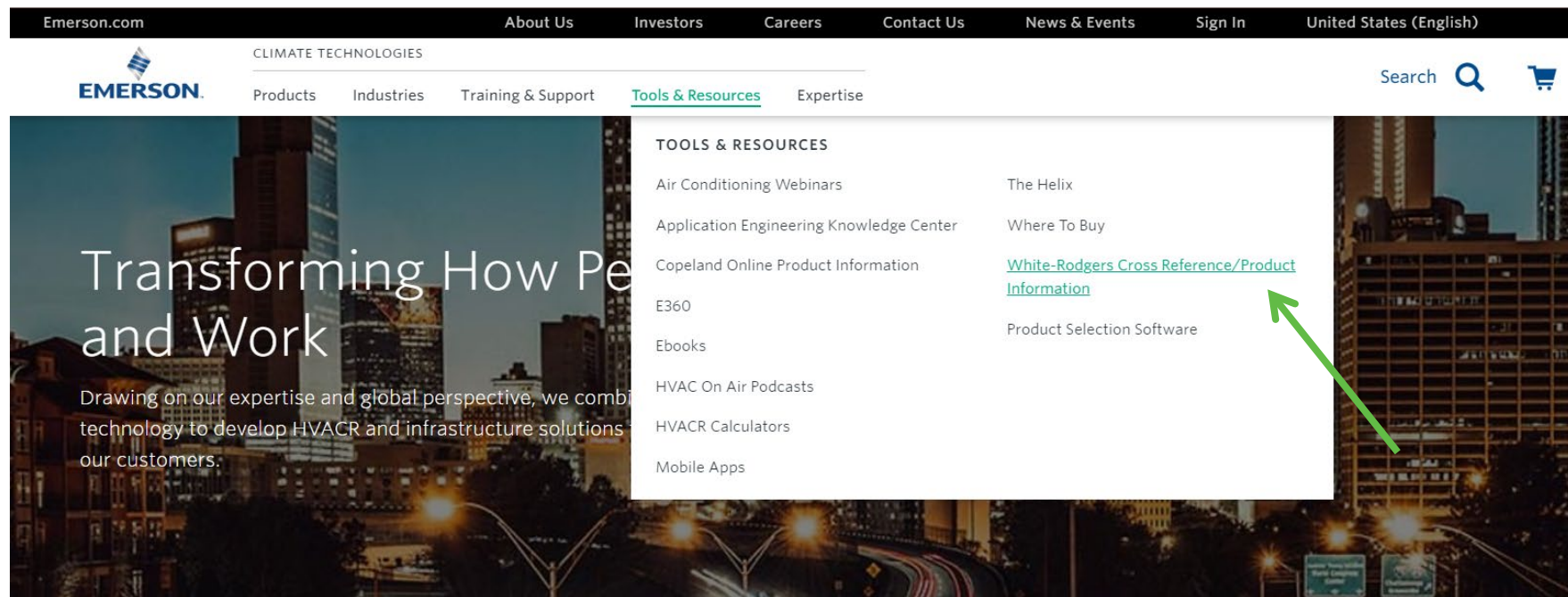

The screenshot displays the Emerson website's navigation menu. The top navigation bar includes links for Emerson.com, About Us, Investors, Careers, Contact Us, News & Events, Sign In, and United States (English). Below this, the 'CLIMATE TECHNOLOGIES' section features the Emerson logo and navigation links for Products, Industries, Training & Support, Tools & Resources (highlighted), and Expertise. A search bar and shopping cart icon are also visible. The 'Tools & Resources' dropdown menu is open, listing various resources such as Air Conditioning Webinars, Application Engineering Knowledge Center, Copeland Online Product Information, E360, Ebooks, HVAC On Air Podcasts, HVACR Calculators, Mobile Apps, The Helix, Where To Buy, [White-Rodgers Cross Reference/Product Information](#) (indicated by a green arrow), and Product Selection Software. The background of the page features a cityscape at night with the text 'Transforming How People and Work' and a sub-headline: 'Drawing on our expertise and global perspective, we combine technology to develop HVACR and infrastructure solutions for our customers.'

Why Contractors Trust White-Rodgers

Industry Leading Products

- Used by more OEM's
- Offering the widest range of Universal Replacement Controls

Ease of Installation

- Simple, easy to understand instructions

Product Reliability

- Quality Control assures reliable products

Affordable

- Competitive pricing

Supported by Knowledgeable Representatives

- Contractor direct phone support



Technical

What's an "IFC"?

IFC stands for "**I**ntegrated **F**urnace **C**ontrol".

Originally, furnaces had separate controls for the ignition/combustion process and controlling the blower. IFC's integrate these functions together. One control monitors and integrates all functions.

IFC jobs include:

- Monitoring flue integrity for safe combustion venting
- Providing ignition and flame supervision to ensure safety
- Operating the combustion inducer motor
- Controlling the fan/blower and associated on/off time delays
- Monitoring and protecting the furnace from overheating
- Interfacing with the thermostat control
- Providing pinpoint diagnostic troubleshooting

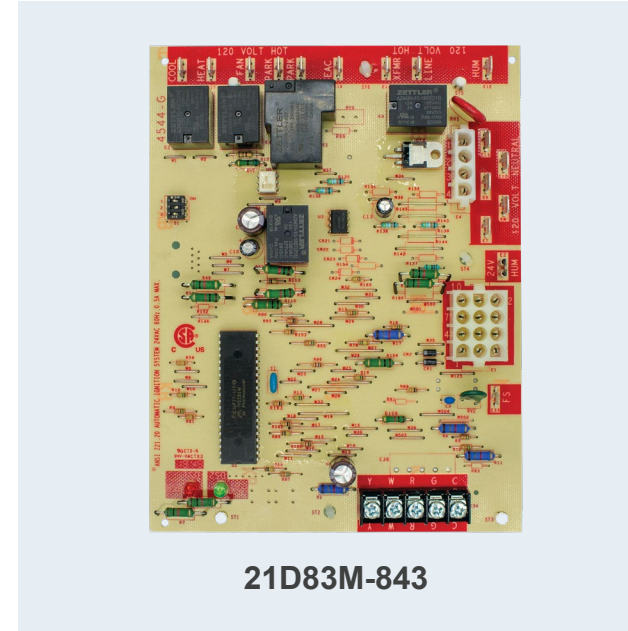

IFC History

1935

- An electric fan to distribute the heated air through ductwork of a coal fired furnace within the home is patented.
- Mechanical temperature switches are used to control when the blower turns on/off.

1968

- An Intermittent Spark ignition system is introduced to replace Standing Pilot Systems.



1988

- A Furnace Blower Control using a microprocessor to time the fan blower on & off instead of a temperature sensing control is patented.

1990

- A fully Integrated Furnace Control that controls the gas valve, gas ignition, flame sensing, fan blower operation, induced draft control and sensing, & limit function control is patented.

Non-integrated Control Operated Furnaces

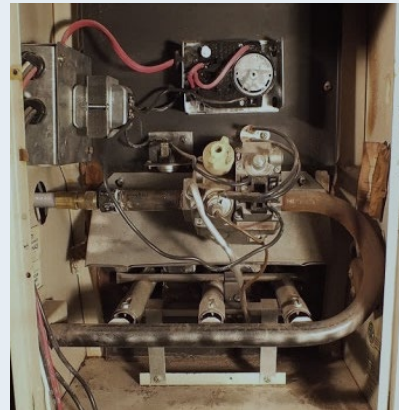
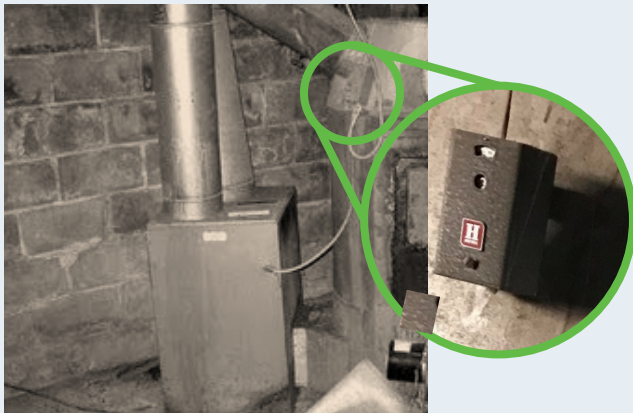

Integrated Furnace Control

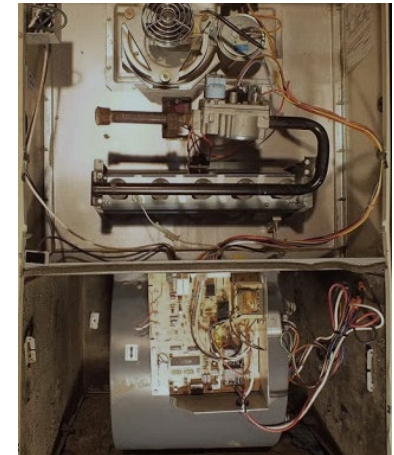

IFC Options / Differences

Ignition Types



- **Hot Surface Ignition** is operated with either Silicon Carbide or Silicon Nitride.
- **Direct Spark Ignition** uses a spark probe to directly ignite burner gas.
- **Proven or Intermittent Pilot** first checks for pilot ignition prior to opening up the main gas valve.

Gas Valve Stages

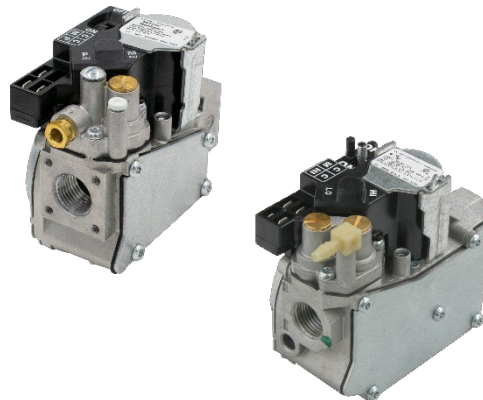

The most popular Furnaces manufactured are single stage but are also made with 2 heating stages or more. The most common are:

- **Single Stage** use a single stage gas valve.
- **Two-Stage** features a high/low fire gas valve. Usually staged open at 40% and then 100%

21D83M-843 Single Stage IFC

Blower Motor Types



- **PSC or Permanent Split Capacitor motors** were regulated out of new residential furnaces made after July 3rd, 2019
- **ECMx or X-13 motors** use a controller to maintain constant torque on the blower shaft.
- **ECMv or Constant Speed motors** use a controller to maintain a constant airflow speed.

80V Hot Surface Ignitors

From about 1997 to 2006 many furnaces used integrated furnace controls featuring 80VAC ignitors, PSC inducer and blower motors and single stage gas valves. The 21D83M-843 is designed as a direct replacement for Lennox models fitting this profile.

Complete cross reference information is available on our website and in our mobile app to assure proper replacement control selection along with alternate control choices and detailed installation information.



TECH TIP: Some Lennox controls from this production era can also be replaced with a Universal Integrated Furnace Control like the 50M56U-843 featuring the HotRod ignitor

Fast Facts 21D83-843

- Lennox targeted replacement
- 80V Ignitor output
- PSC Inducer and blower control
- Single stage gas valve control
- Heat, Cool, Fan, speed taps
- R, C, W, Y, G Thermostat connection
- Two conversion wiring harnesses and a quick connect breaker for increased application versatility
- Mounting options include standoff or metal mounting plate
- Detailed instruction sheet makes installation easy

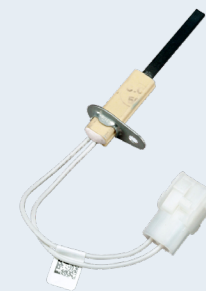

White-Rodgers Universal 50M56U-843 Components

24v Components:

1. Flame Sense Spade
2. 12-pin Molex Connector
3. 24v Thermostat Bus
4. Humidifier Spade
5. Status / Fault LED
6. Heat On/Off, Fan Dipswitches

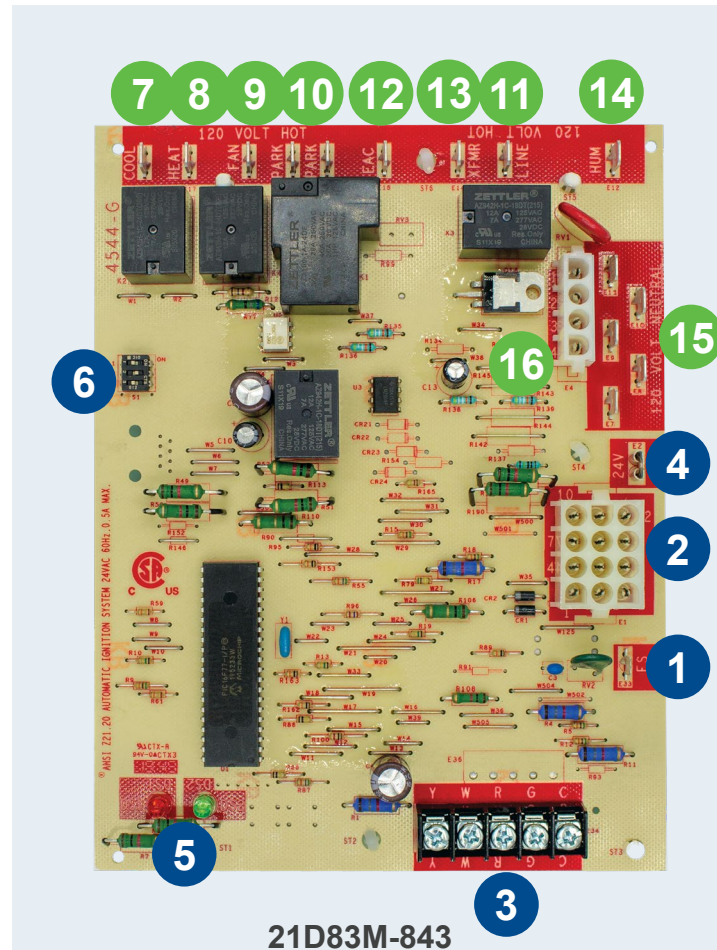

21D83M-843

21D83M-843 Single Stage IFC

120v Components:

7. PSC Blower Cool Spade
8. PSC Blower Heat Spade
9. PSC Blower Fan Only Spade
10. 2 Extra Blower Speed Park Spades
11. Electronic Air Cleaner Spade
12. Line 120v Input Spade
13. 120v Transformer Spade
14. 120v Humidifier Spade
15. 5 Line Neutral Spades
16. 4-pin Inducer/Ignitor Molex Plug

What's In The Box?

Kit includes:

- 1 – Ignition control board
- 1 – Wiring harness adaptor (9-pin to 12-pin)
- 1 – Wiring harness adaptor (4-pin to 6-pin)
- 1 – Mounting panel
- 4 – Stand-off fasteners
- 1 – Circuit breaker
- 1 – 4" blue wire extension
- 2 – Wiring diagram labels

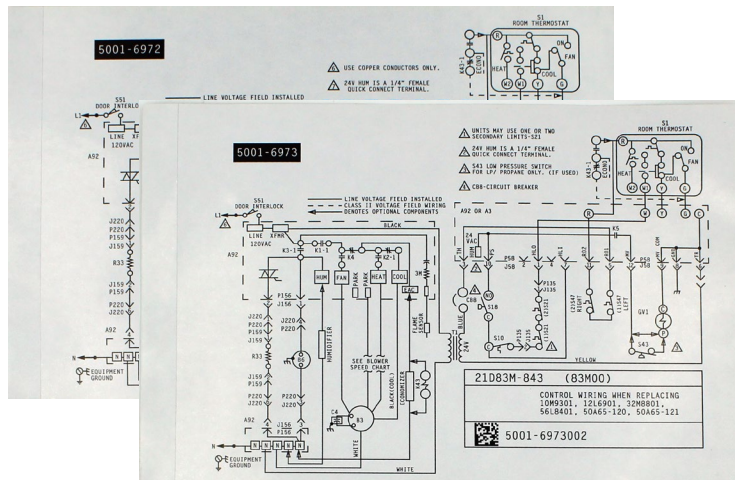

Adjustable Fan Delay Dipswitch Functions

Control has 1 set of dipswitches:

Dipswitch Settings

HEAT delay-to-fan-off:	Set switch #1	Set switch #2
60 sec.	Off	Off
90 sec.*	Off	On
120 sec.	On	Off
180 sec.	On	On

COOL delay-to-fan-off:	Set switch #3
2 sec.	Off
45 sec.*	On

*Factory Setting

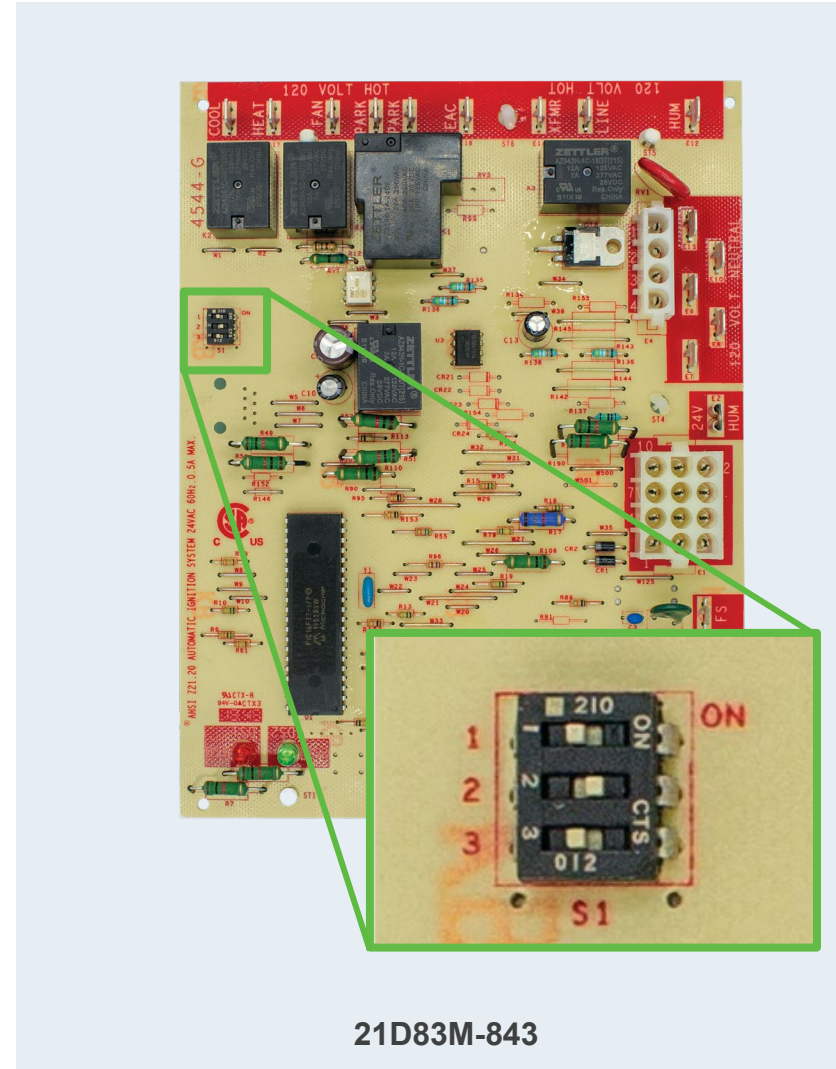

21D83M-843

TECH TIP: Power must be cycled after dipswitch settings are made.

21D83M-843 Diagnostics

System troubleshooting is easy with dual LED diagnostics

DS 1 (Red LED)	DS 2 (Green LED)	Error/Condition
Simultaneous slow flash	Simultaneous slow flash	Normal operation
Simultaneous fast flash	Simultaneous fast flash	Normal operation with call for heat
Slow flash	On	Open limit switch
Off	Slow flash	Pressure switch stuck closed/open
Alternate slow flash	Alternate slow flash	External lockout (retries)
Slow flash	Off	Flame sensed with gas valve de-energized
On	Slow flash	Open rollout switch
On	On	Module – internal fault condition
Slow flash	Fast flash	Low flame sense current
Fast flash	Slow flash	Grounding or reversed polarity
Alternate fast flash	Alternate fast flash	Module ignitor contact failure

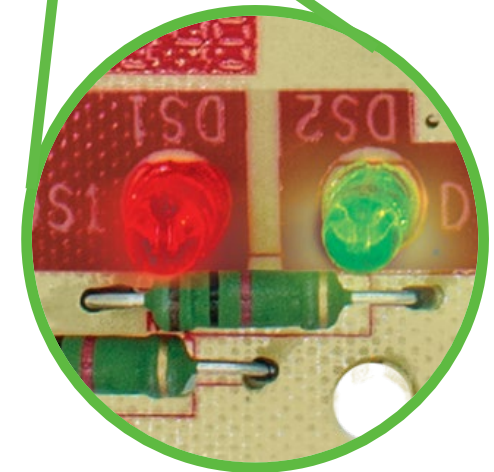
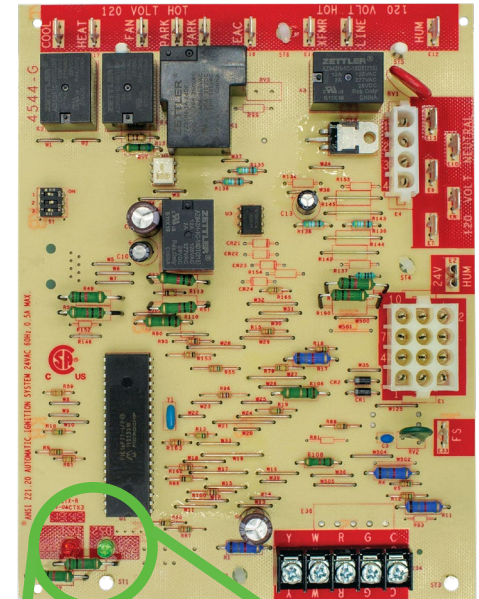

TECH TIP: 21D83 instructions also provides troubleshooting tips for each diagnostic flash code that occurs.

Install

What's In The Box?

Kit includes:

- 1 – Ignition control board
- 1 – Wiring harness adaptor (9-pin to 12-pin)
- 1 – Wiring harness adaptor (4-pin to 6-pin)
- 1 – Mounting panel
- 4 – Stand-off fasteners
- 1 – Circuit breaker
- 1 – 4" blue wire extension
- 2 – Wiring diagram labels

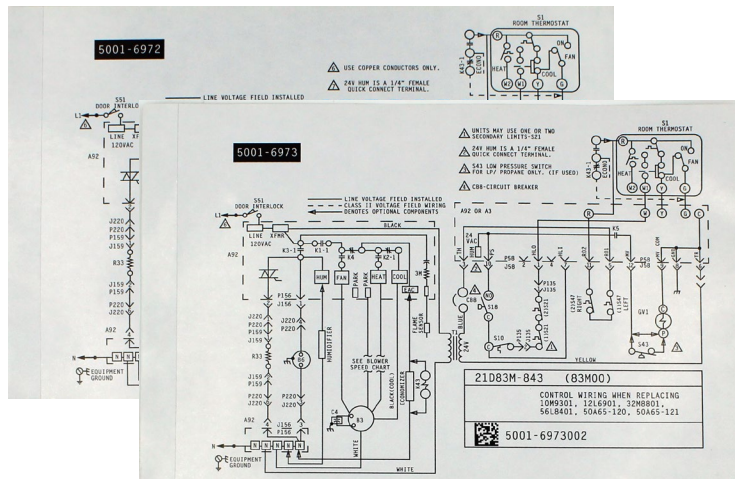

Replacement Procedure Summary

Using the installation guide, choose the correct replacement procedure based on the model being replaced.

Procedure 1 - Install mounting panel and breaker*

Procedure 2 - Install mounting panel, both conversion harnesses and breaker*

Procedure 3 - Direct board replacement, no kit components required

For this tutorial, procedure 2 will be used.

* Breaker only required on furnaces *without* low voltage fuse or breaker.



TECH TIP: Once the board has been cross-referenced, instructions clearly illustrate steps.

Find Correct Replacement Procedure

Locate the old board number being replaced in the 21D83M instructions (summary below).

Old Board Number	Replacement Procedure #	Old Board Number	Replacement Procedure #	Old Board Number	Replacement Procedure #
100925-01	3	30W25	3	56L84	1
100925-02	3	30W2501	3	56L8401	1
100925-03	3	32M88	1	63K89	2
10M93	1	32M8801	1	63K8901	2
10M9301	1	50A62-120	2	65867	3
124110	3	50A62-121	2	69M08	3
12L69	1	50A62-820	2	69M0801	3
12L6901	1	50A65-120	1	69M15	3
17W92	3	50A65-121	1	69M1501	3
17W9201	3	50A66-122	3	83M00	3
21D83M-843	3	50A66-123	3	83M001	3
23W51	3	50A66-743	3	97L48	2
23W5101	3	50A66-843	3	97L4801	2
24L85	2	56L83	2		
24L8501	2	56L8301	2		

Disconnect Power and Gas

- 1 Turn off the power and gas to the furnace and remove the access panels.



Check Cross Reference

2 Check the old part number against the 21D83-843 box cross reference or WR Mobile.

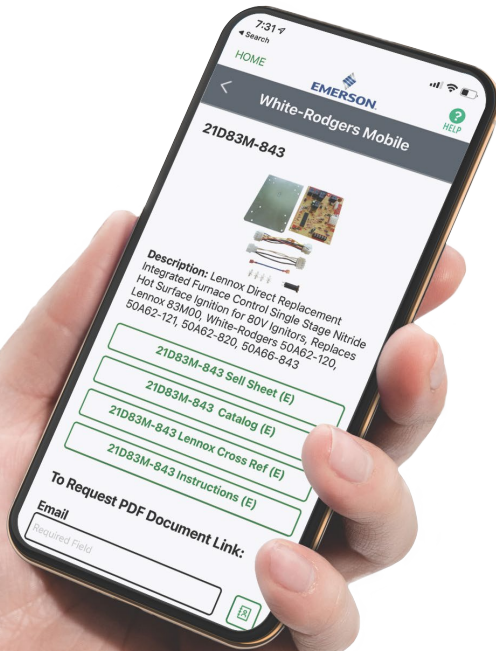

White-Rodgers®
Integrated Furnace Control
21D83M-843 | Lennox

D
OEM Direct

Single Stage Applications
PSC Blower Motor
80V HSI Ignition



Trusted by **PROs** 1-Year Limited Warranty

EMERSON
Climate Technologies

Cross Reference Replacement / Tableau de renvoi des remplacements

Lennox	White-Rodgers
124110	21D83M-843
24L85	50A62-120
24L8501	50A62-121
56L83	50A62-820
56L8301	50A66-843
63K89	
63K8901	
65867	
83M00	
83M001	
97L48	
97L4801	
L39-564	

Take a Picture of Wiring

- 3 Take pictures before removing any wiring. Label existing wiring, as necessary.



21D83M-843 Single Stage IFC

Disconnect Wiring

4

- Flame sense connection
- Molex connectors
- Thermostat wiring
- Blower motor wires
- 120V line voltage connections
- Transformer connections
- Remove the old board

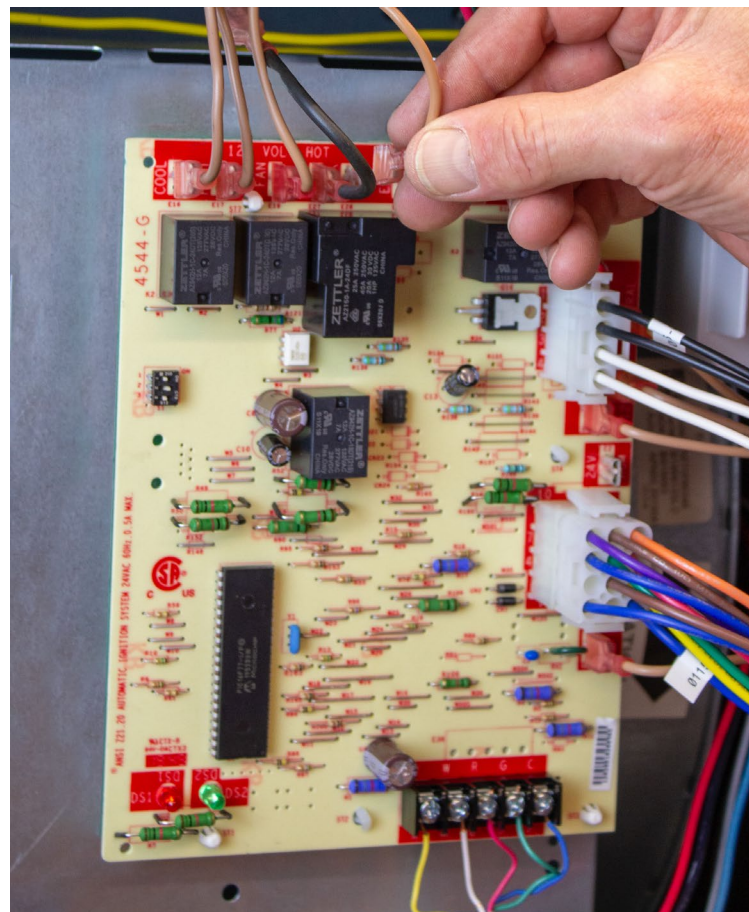

Dipswitch Settings

- 5 Set fan delay dipswitches to match the old control settings.

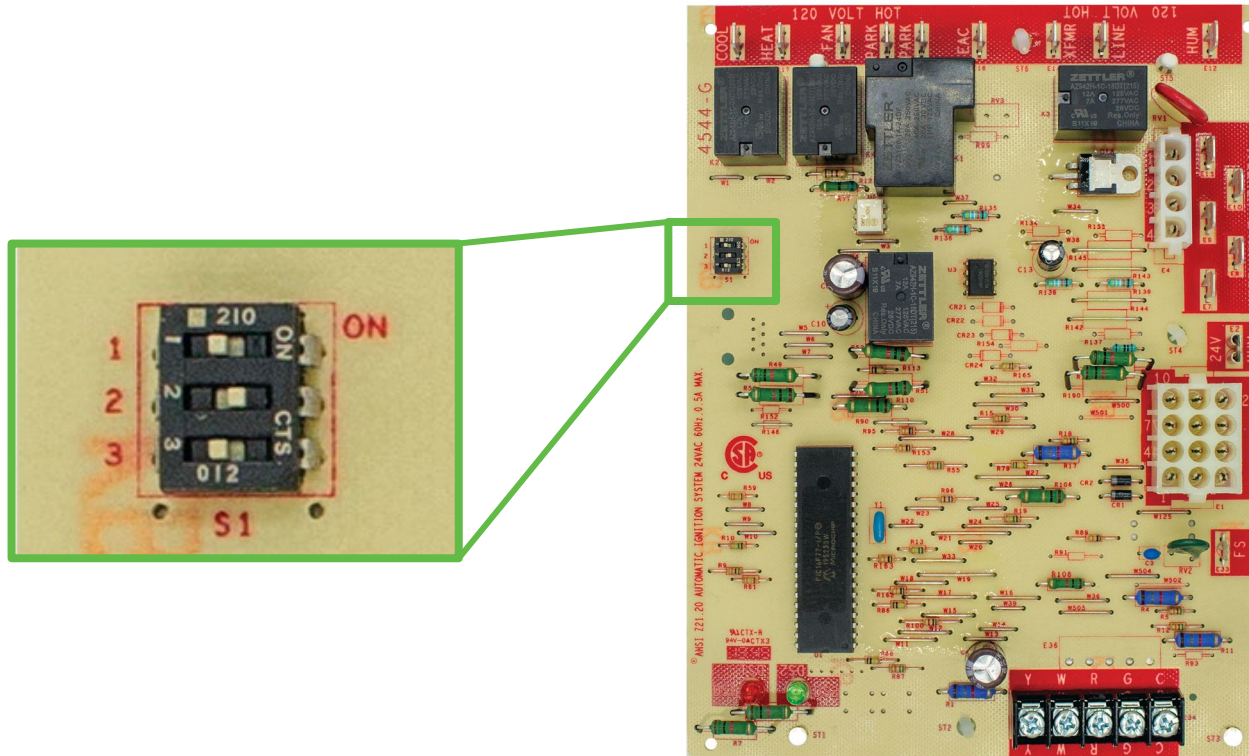

 **TECH TIP:** The switches can be moved with a small screwdriver.

Mount Board

- 6 Mount the new board using the old mounting holes, new mounting plate or re-drilling procedure.

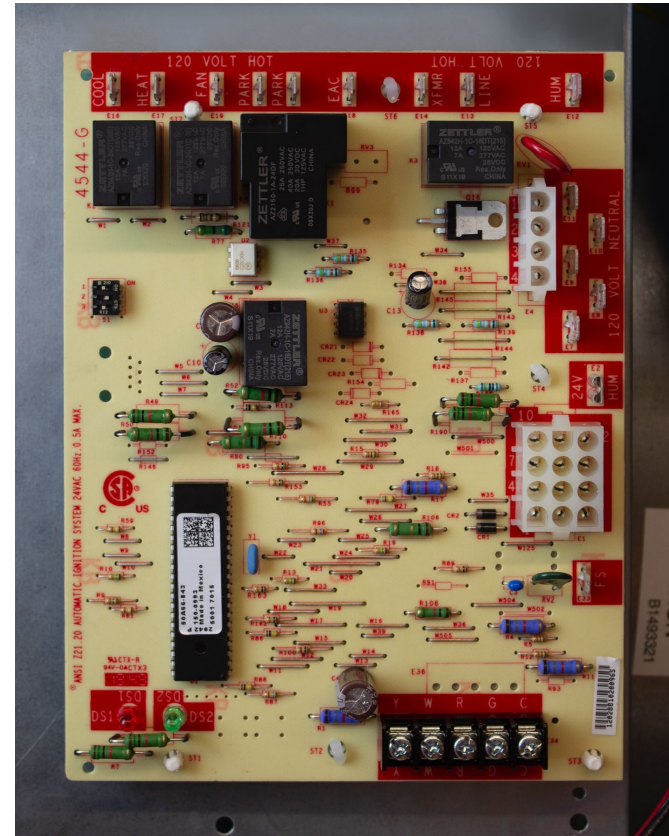
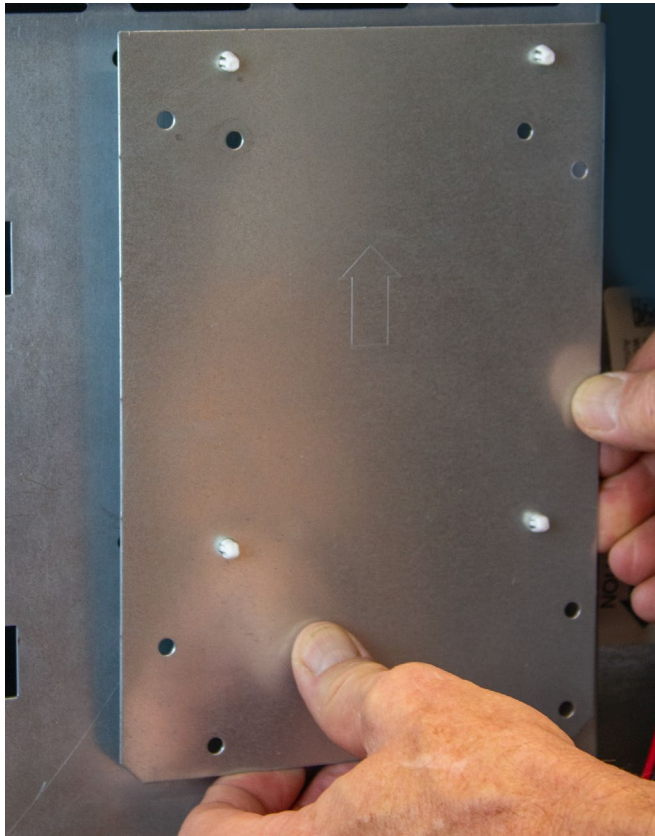

Circuit Breaker

- 7 On furnaces without a low voltage fuse or breaker insert the included circuit breaker in series between the blue wire on Pin 3 of the wiring harness (9-pin to 12-pin) and the blue transformer wire. Use the 4" blue wire provided for transformers with a quick-connect terminal.

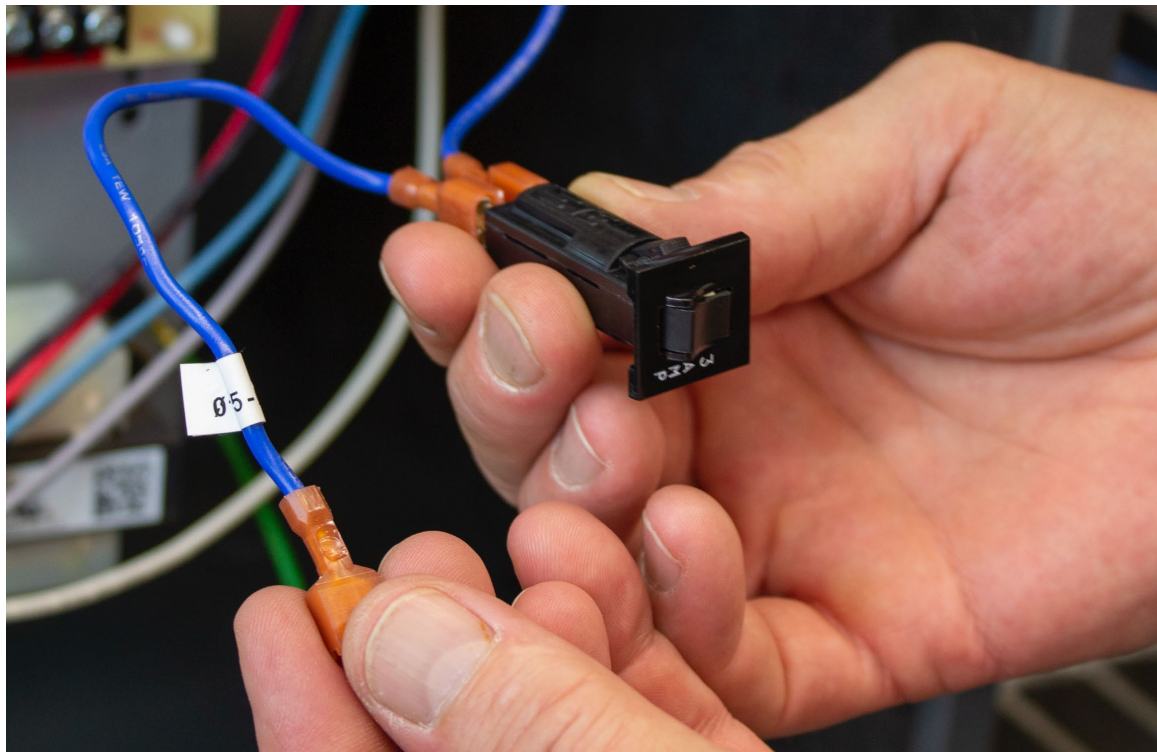

Connect Wiring Harnesses

- 8 Connect the provided 9-pin to 12-pin wiring harness to the unit 9-pin connector. Connect the provided 4-pin to 6-pin wiring harness to the unit 6-pin connector.

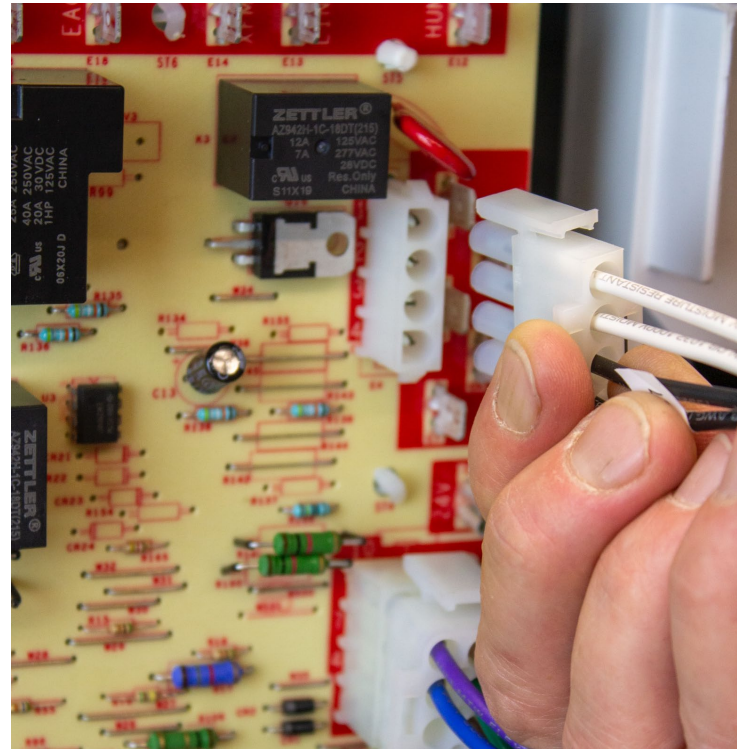
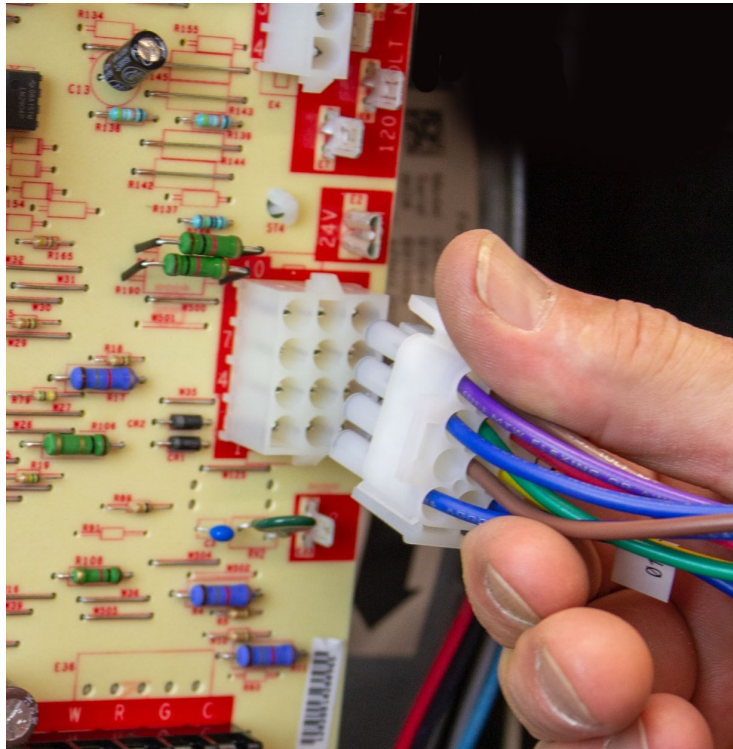

Connect Transformer Wire

- 9 Connect the yellow wire from position 6 on the 12-pin connector to the yellow transformer wire.

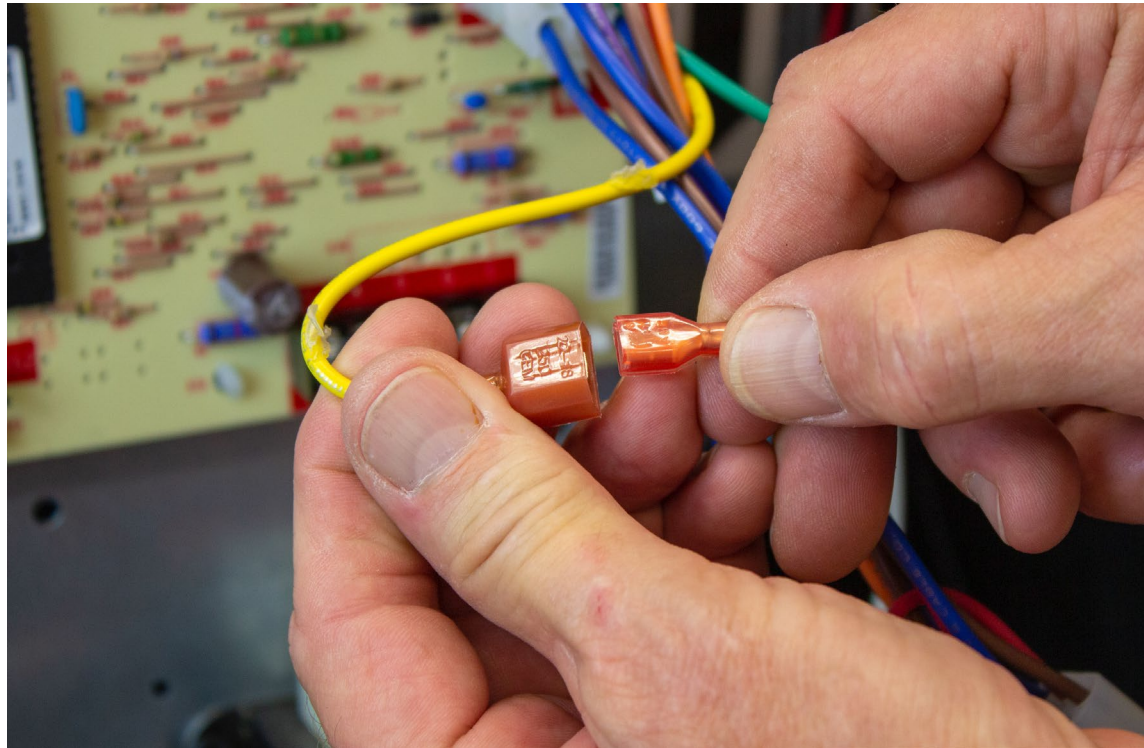

Connect GND

- 10 Connect GND wire to equipment ground.

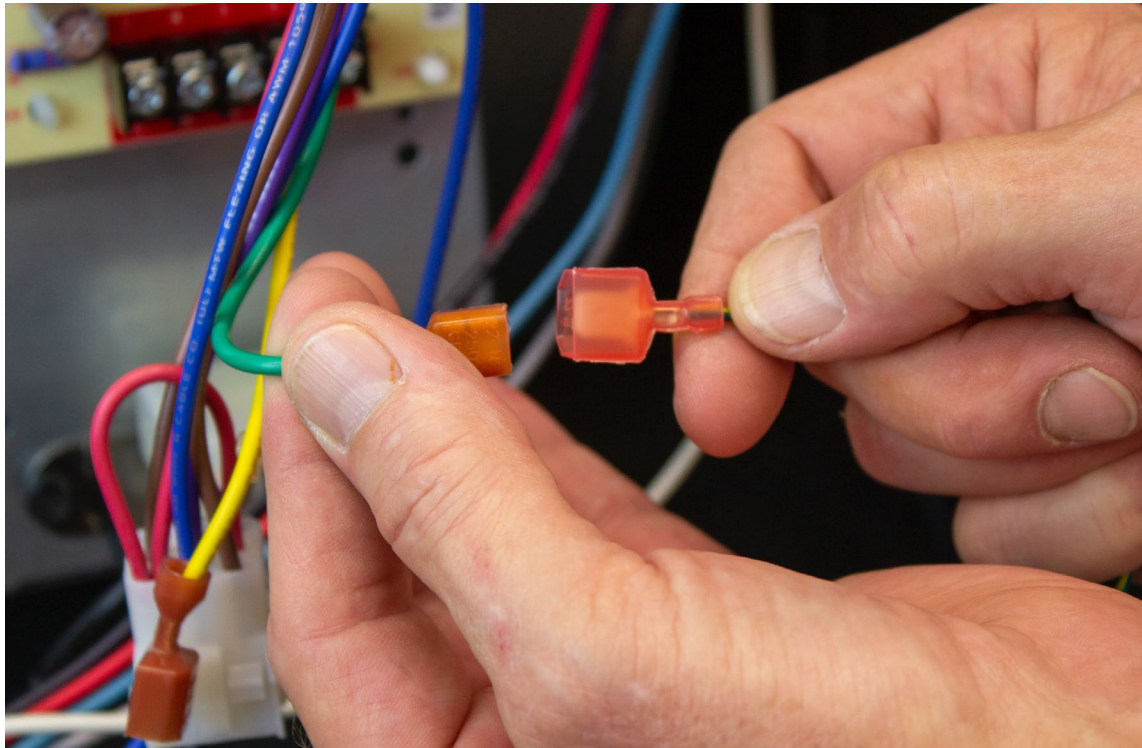

Connect Remaining Wires

- 11** Connect the remaining 120 VAC hot and neutral wires and the flame sense wire to the replacement control per table 2.

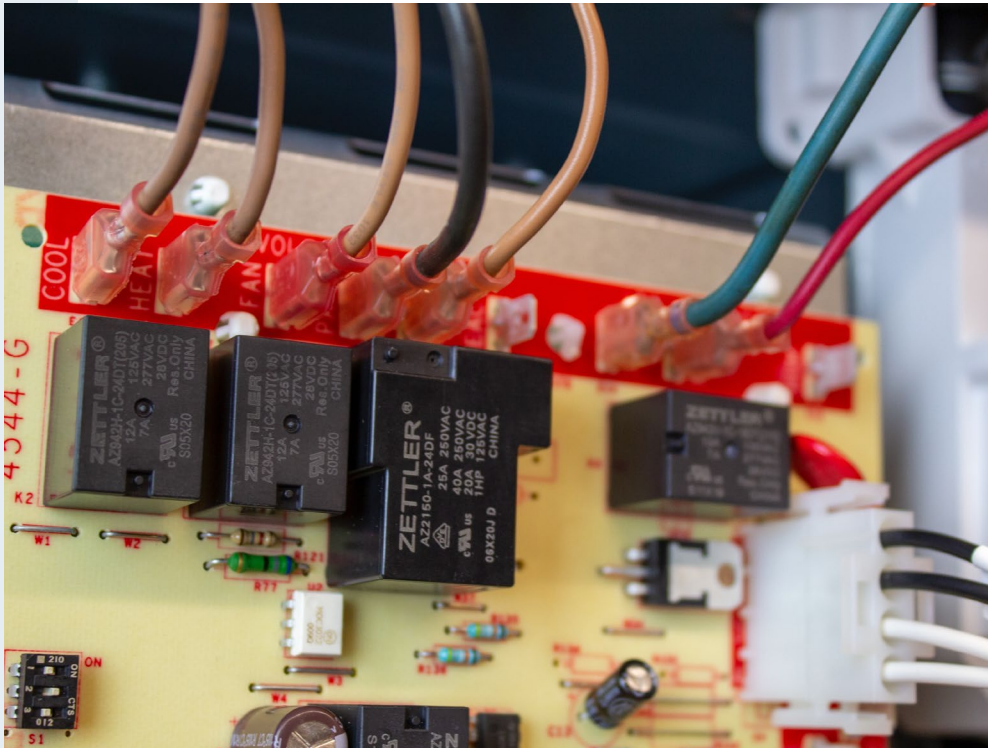
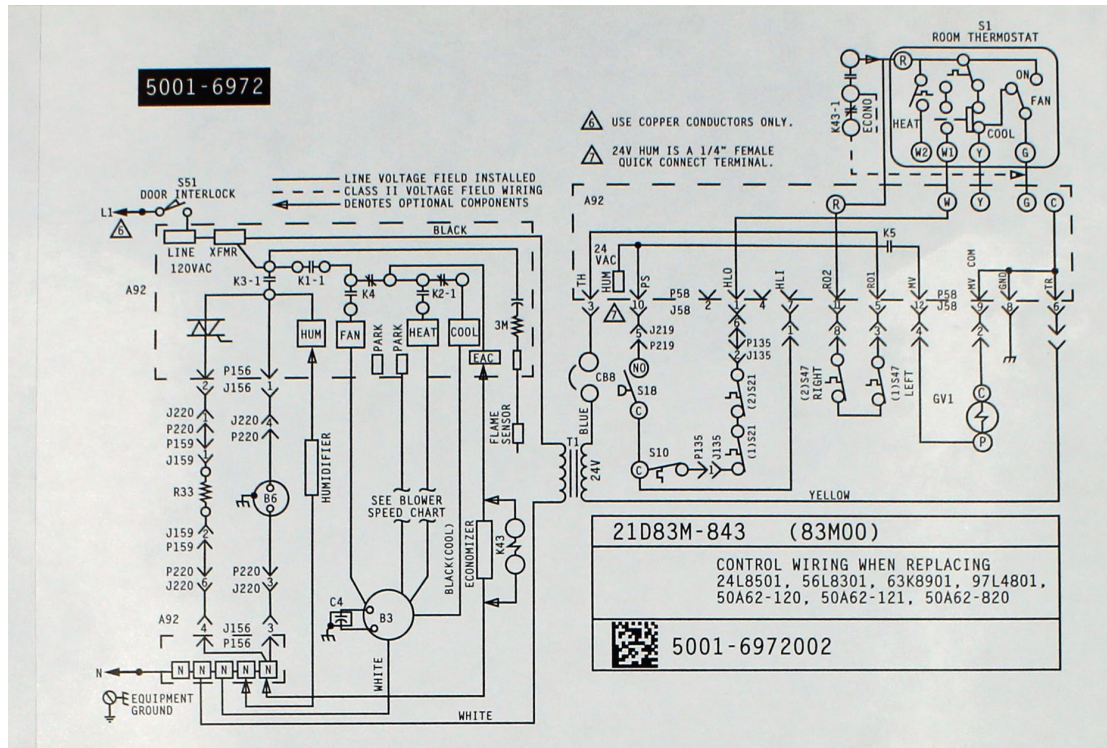

TABLE 2

Type	Existing Control Board	Replacement Control Board
L1 120 VAC	ACB COOL	COOL
	ACB HEAT	HEAT
	PARK M1	PARK
	PARK M2	PARK
	ACC	EAC
	120 VAC HOT	LINE
	120 VAC TX	XFMR
	HTG ACC	HUM
ACB LOW	FAN	
Neutral 120 VAC	Neutral 120 VAC Return (5)	Neutral 120 VAC (5)
Flame Sense	E33	FS

Wiring Diagram

12 Affix wiring diagram 5001-6972 adjacent to the existing unit wiring diagram



Connect Power and Gas

- 13 Replace the access panel. Restore the electrical power and gas supply. Refer to the furnace installation instructions for start-up and check-out procedures.



Troubleshooting

See page 7 of the installation guide.

DIAGNOSTIC TABLE			
DS 1 (Red)	DS 2 (Green)	Error/Condition	Comments/Troubleshooting
Simultaneous slow flash	Simultaneous slow flash	Normal operation	No fault
Simultaneous fast flash	Simultaneous fast flash	Normal operation with call for heat	Normal operation
Slow flash	On	Open limit switch	Verify continuity through rollout switch circuit
Off	Slow flash	Pressure switch stuck closed/open	Pressure switch stuck closed. Check switch function, verify inducer is turning off. Pressure switch stuck open. Check pressure switch function and tubing. Verify inducer is turning on and pulling sufficient vacuum to engage switch.
Alternate slow flash	Alternate slow flash	External lockout (retries)	Failure to sense flame is often caused by carbon deposits on the flame sensor, a disconnected or shorted flame sensor lead or a poorly grounded furnace. Carbon deposits can be cleaned with emery cloth. Verify sensor is not contacting the burner and is located in a good position to sense flame. Check sensor lead for shorting and verify furnace is grounded properly.
Slow flash	Off	Flame sensed with gas valve de-energized	Verify the gas is operating and shutting down properly. Flame in burner assembly should extinguish promptly at the end of the cycle. Check orifices and gas pressure.
On	Slow flash	Open rollout switch	Verify continuity through rollout switch circuit.
On	On	Module – internal fault condition	Module contacts for gas valve not operating or processor fault. Reset control, if condition persists, replace module.
Slow flash	Fast flash	Low flame sense current	Low flame sense current is often caused by carbon deposits on the flame sensor, a poorly grounded furnace or a mis-aligned flame sense probe. Carbon deposits can be cleaned with emery cloth. Check or improve furnace and module ground. Verify sensor is located in or very near flame as specified by the appliance manufacturer.
Fast flash	Slow flash	Grounding or reversed polarity	Verify the control and furnace are properly grounded. Check and reverse polarity (primary) if incorrect.
Alternate fast flash	Alternate fast flash	Module ignitor contact failure	Fault code indicates the module ignitor contacts are not functioning properly. Replace module.